

INSTALLATION INSTRUCTIONS

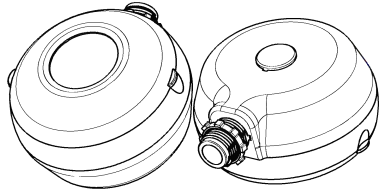

MPC-50HD

High Bay 360° Passive Infrared Line Voltage
Occupancy Dimmer Sensor



SPECIFICATIONS

Voltage	120/277VAC, 50/60Hz
Resistive.....	10A
Tungsten.....	800W
Electronic Ballast.....	800VA/120VAC, 1600VA/277VAC
Dimmable Ballasts or LED Drivers.....	1-10VDC
Motor.....	1/4 HP
Adjustable Light Level.....	30FC—500FC
Sensitivity Adjustable.....	0-20 feet
Coverage:	
MPC-50HD-L1: Mounting height: 50ft	Field of view: 360° Coverage :2800 sq.ft
MPC-50HD-L2: Mounting height: 8ft	Field of view: 360° Coverage :1200 sq.ft
Operating Temperature	32°to 131°F (0°to 55°C)

DESCRIPTION

The MPC-50HD 360° occupancy sensor uses advanced PIR technology to turn on the lights when motion is detected and dim the lights if vacancy is detected. The sensor will automatically turn off the lights if no movement is detected within the amount of time selected in the time delay.

The MPC-50HD is specially designed for use in areas with high ceilings such as warehouses, distribution centers, and gymnasiums along with 1-10VDC fixtures. Be sure to attach the appropriate lens based on the ceiling height.

There are 4 operating modes to choose base on the condition of the space and energy usage.

There are two lens choices available, lens 1 and lens 2. Lens 1 is an extended range lens that provides up to 2800 sq. ft. of coverage at a maximum installation height of 50 ft.

Lens 2 is a high density lens that provides up to 1900 sq. ft. of coverage at a recommended installation height of 8-10 ft.

COVERAGE

Lens choices:

The coverage area is determined by the type of lens attached to the MPC-50HD. (See Figure 1).

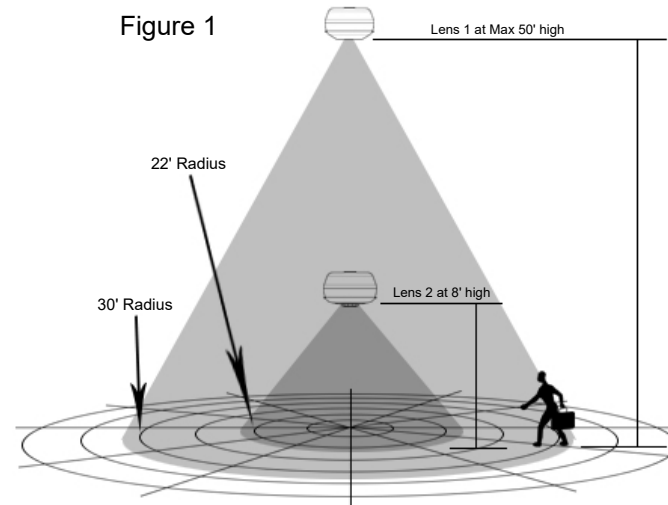
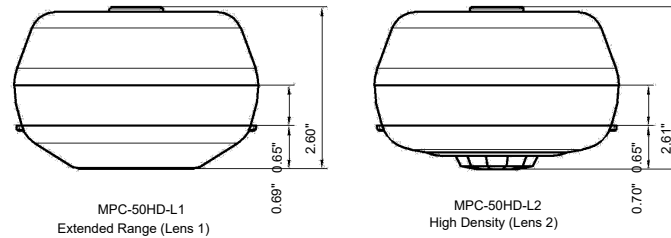

WARNING

Turn the POWER OFF at the circuit breaker before installing the sensor

Read and understand these instructions before installing. This device is intended for installation in accordance with the National Electric Code and local regulations. It is recommended that a qualified electrician performs this installation. Make sure to turn off the circuit breaker or fuse(s) and make sure power is off before wiring the device. Use copper wire only, or equivalent.

WIRING DIRECTIONS

Refer to the wire diagram of the sensor (See Figure 2)

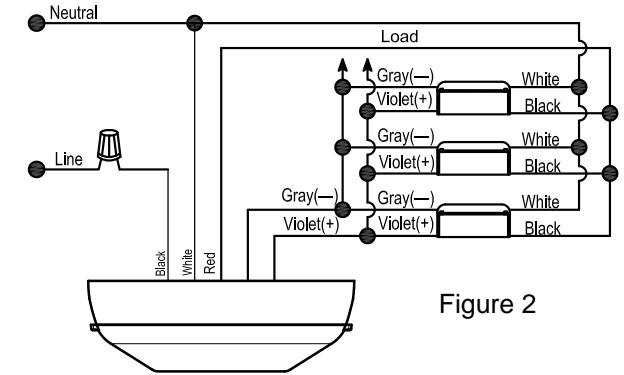

Figure 2

INSTALLATION

The MPC-50HD can be directly attached to the fixture or ceiling, or attached to the fixture or junction box with the provided housing. (See Figure 3 and 4 below)

Mounting the Housing

The Housing comes ready to install on the side of a fixture or junction box. To mount the Housing on the surface of the fixture or ceiling, twist off the lock nut on the connector and remove the connector. Then install it on the back of the Housing and cover the side knockout with the knockout cover.

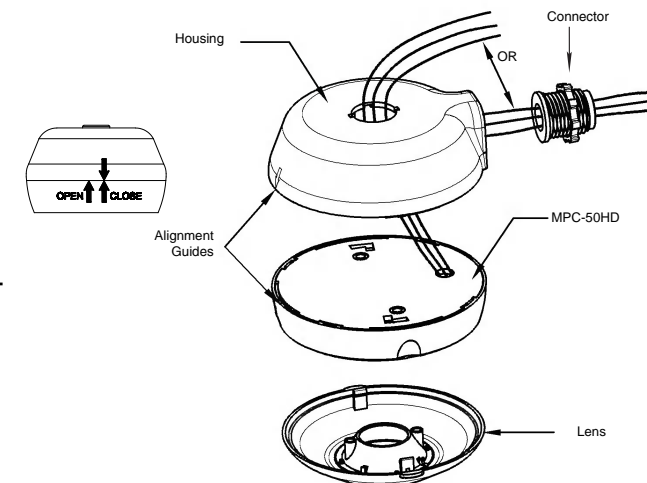

Figure 3

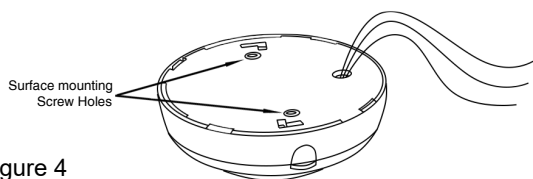
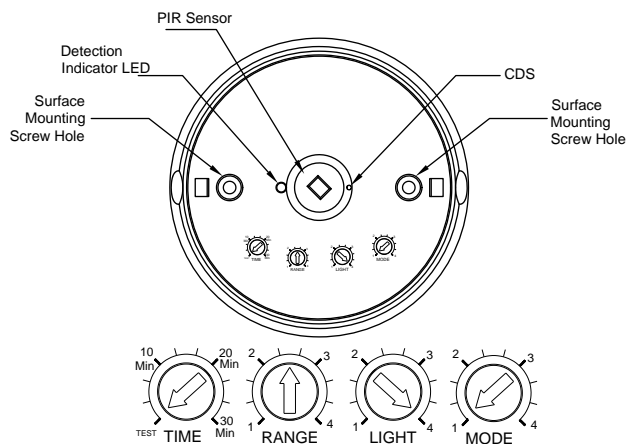

Figure 4

SENSOR SETTINGS



Time Delay Knob

- Default position: 15 Seconds (Test mode)
- Time Delay Adjustable : from 15s to 30min (clockwise)

Sensor Sensitivity Range Knob

- Default position: Adjustable: 30% (Position 1) to 100% (Position 4)
- Turn toward right for greater room space.
- Turn toward left to avoid false alert in smaller room and near the door way or heat source.

Ambient Light Level Knob

- Default position: Daylight (100% at position 4)
- Adjustable: Turn to the position 1(counter clockwise), the light threshold value is 300 lux.
- Turn to the position 4 (clockwise), regardless of ambient light level, control by PIR.
- Turn to 90% of the full range position 3 (clockwise), the light threshold value is 4000lux.

Operating Modes Knob

- Mode 1: Turn to the position 1, the Light will automatically turn ON by PIR and its output is 10V. Auto OFF by preset time delay
- Mode 2: Turn to the position 2, the Light will automatically turn ON by PIR and its output is 5V. Auto OFF by preset time delay.
- Mode 3: Turn to the position 3, the Light will automatically turn ON by PIR and its output is 10V, after the preset time delay expires its output will reduce to 5V. After 30 minutes the lights will turn off if no motion is detected. When motion is detected within 30 minutes the sensor will reverse to its original mode 3 state.
- Mode 4: Turn to the position 4, the Light will automatically turn ON by PIR and its output is 10V, after the preset time delay expires its output will reduce to 5V. After 30 minutes the lights will continue to stay on indefinitely at 5V output. When motion is detected within 30 minutes the sensor will reverse to its original mode 4 state.

TROUBLESHOOTING

LED does not blink:

Check sensor mounting place, verify the sensor can detect motion from human body. If not, the LED will not blinks.

LED blinks but lights do not turn ON:

1. Make sure the wire connections are correct. Red load wire lead to load light, and check the wire connections.
2. Make sure that power to the sensor has been ON continuously for at least 5 seconds. Wait for the warm-up period to end, and if LED lighting, the load has not turn on, then go to next step.
3. Cover the light sensor lens to simulate darkness.If the light turns ON, the light level setting needs to be adjusted. If set for minimum, more than 2fc of ambient light causes the lights to be held OFF.
4. Check security of the light fixture.

Lights will not turn OFF:

1. If there is no motion from people or equipment in the sensor's view but the LED blinks, look for any nearby source of infrared energy (heat) in motion, such as turbulent air from a heating or cooling supply. Mount the sensor so that it's lens is below the edge of the fixture and does not directly view the lamps. Move the air supply away from the sensor,or move the sensor.
2. Verify time delay by adjust the time knob. The time delay can be set from 15 seconds to 30 minutes(clockwise). Ensure that the time delay is set to desired delay and that there is no movement within the sensor's view for that time period.
3. Check sensor wire connections, verify load and neutral wires are secure.

WARRANTY INFORMATION

This device is warranted to be free of material and workmanship defects for 2 years from the date of purchase. Original receipt or proof of purchase from an authorized retailer must be presented upon warranty claim. ALL claims must be verified and approved by Enerlites, Inc. Warranties from other Enerlites products may vary. This warranty is nontransferable and does not cover normal wear and tear or any malfunction, failure, or defect resulting from misuse, abuse, neglect, alteration, modification, or improper installation. To the fullest extent permitted by the applicable state law, Enerlites shall not be liable to the purchaser or end user customer of Enerlites products for direct, indirect, incidental, or consequential damages even if Enerlites has been advised of the possibility of such damages. Enerlites' total liability under this or any other warranty, express or implied, is limited to repair, replacement or refund. Repair, replacement or refund are the sole and exclusive remedies for breach of warranty or any other legal theory.