

INSTALLATION INSTRUCTIONS

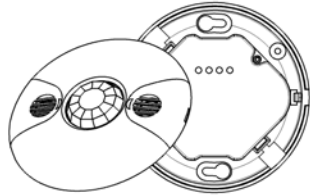

MDC-50L

360° Dual-Technology PIR/Ultrasonic
Low Voltage Occupancy Sensor



SPECIFICATIONS

| | |
|------------------------------|----------------------------------|
| Voltage | 24VDC |
| Current Consumption..... | .20mA |
| Power Supply..... | MPP-24 Power Pack (Not Included) |
| Operating Temperature | 32° to 131°F (0° to 55°C) |
| Adjustable Time Delay..... | 5 Sec. to 30 Min. |
| Adjustable Light Level | 100 Lux -daylight(trimptot 2) |
| PIR Adjustment..... | 50% or 100% (DIP switch 1) |
| Ultrasonic Adjustment | Minimum to Maximum (trimptot 1) |
| PIR Coverage..... | 1600ft ² |
| Ultrasonic Coverage..... | 1000ft ² |

DESCRIPTION

The MDC-50L 360° Dual-Technology Occupancy Sensor combines advanced passive infrared (PIR) and ultrasonic technologies into one unit. The combined technologies help to avoid false triggering. Selectable operating modes allow the sensor to turn a load on, and hold it on as long as either or both technologies detect occupancy. After no movement is detected for the selected time delay, the lights switch off.

The MDC-50L operates on 24V supplied by the MPP-24 Power Packs (Not Included)

COVERAGE

The MDC-50L provides a 360° coverage pattern. The coverage shown represents walking motion at a mounting height of 9 feet. For building spaces with lower levels of activity or with obstacles and barriers, coverage size may decrease.

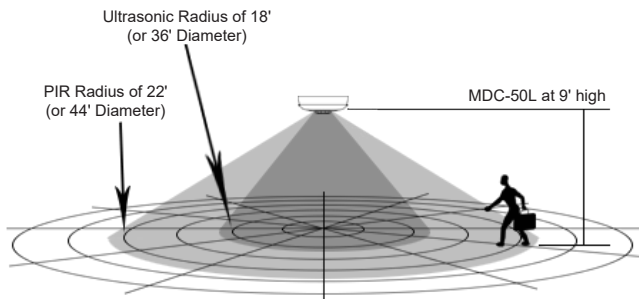

Location: Device should be mounted in a location free of obstruction from furniture, plants, walls and vibration (see Figure 1). The sensor must be mounted a minimum of 4 ft. away from any air vents. Avoid mounting the sensor close to heat source. When mounting directly to a ceiling light fixture, the lens of the sensor must be below the lowest point of the fixture.

MDC-50L is designed for a ceiling height of about 8-10 feet. Because of the umbrella shaped coverage pattern, mounting above or below the recommended height could reduce coverage range and sensitivity. It is not necessary to have occupancy sensor coverage on every square inch of space in any particular room.

The best location to install multiple MDC-50L is usually in the walkways of an open office space (see Figure 2).

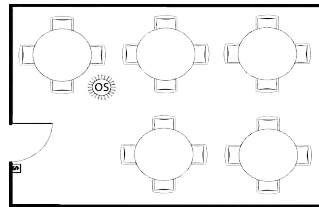

Figure 1

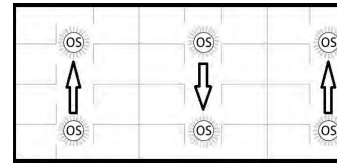

Figure 2

Helpful hints:

- Make sure that the sensor's view of the entrance will not be blocked by the door when it is open.
- Program a longer time out to avoid the lights constantly turning on/off.
- Do not mount sensors close to air vents.
- Cover the main walkways.
- Try to avoid having the sensor looking out the door of the space

Open Office or Classroom Area Coverage:

- To get complete coverage in an open office area, install multiple sensors so that there is at least 15% overlap with each adjacent sensor's coverage area.
- The sensors should cover the primary occupant's desk, the entrance and any other areas with heavy traffic.

WARNING

Turn the POWER OFF at the circuit breaker before installing the sensor

Read and understand these instructions before installing. This device is intended for installation in accordance with the National Electric Code and local regulations. It is recommended that a qualified electrician performs this installation. Make sure to turn off the circuit breaker or fuse(s) and make sure power is off before wiring the device.

Use copper wire only.

WIRING DIRECTIONS

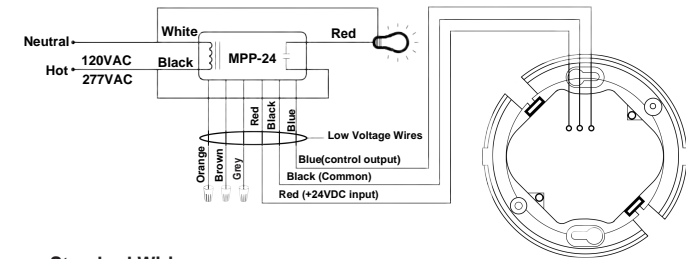

Figure 3

Standard Wiring:

- RED — +24VDC Input
- BLACK — Common
- BLUE — Control Output

LIGHT LEVEL ADJUSTMENT

The sensor may be adjusted to operate at the desired level of ambient light. To do so, turn the dial to point the arrow toward the "-" sign for sensor to detect motion and operate during low light or no light. Point the arrow toward the "+" sign for sensor to operate when there's more light in the area or even during daylight.



Light

NOTE: The light level is adjustable only when the time delay is set at or above 30 seconds.

SENSOR ADJUSTMENT

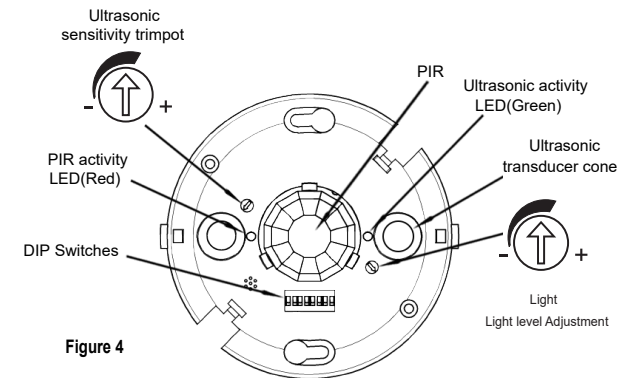

Figure 4

ULTRASONIC LEVEL ADJUSTMENT

Ultrasonic Sensitivity Adjustment Dial

Adjustable: Minimum (counterclockwise) to Maximum (clockwise)



Note: Turn toward right for greater room space. Turn toward left to avoid false alert in smaller room and near the door way or heat source.

MOUNTING USING AN OCTAGONAL J-BOX (not included)

1. Pull the high voltage wires from the power pack into the J-Box through the conduit knockout.
2. Connect the high voltage wires to the appropriate terminals on the sensor.
3. Loosen the appliance mounting screws attached to the J-Box.
4. Align the sensor to the J-Box so that the mounting screws on the box match the key holes on the sensor's Main Body.
5. Push the sensor up into the J-Box and twist it so that the mounting screws are seated in the keyhole slots.
6. Tighten the two screws to secure the sensor to the J-Box.
7. Snap on the front cover onto the sensor.

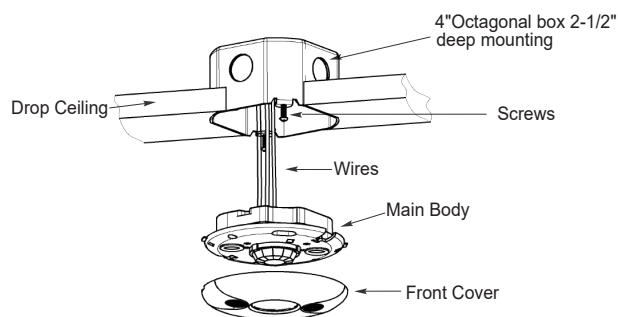

TESTING OCCUPANCY SENSOR

Note: There is a 40-second warm-up period when power is first applied. Use a small screwdriver to open the front cover and make changes to the settings. The pre-set time delay is Test mode and light level is set at maximum

Refer to Figure 3 on previous page.

1. Ensure the PIR Activity is enabled, red LED flashes, PIR Sensitivity is set to 100% (DIP switch 1 ON) and Ultrasonic Level is set to Maximum.
2. Ensure the Time Delay is set for Test Mode.
3. Ensure that the Light Level is at the maximum position. (see "LIGHT LEVEL ADJUSTMENT").
4. Remain still. The red LED should not flash. The lights should turn off after 15 seconds. (If not, see "TROUBLESHOOTING.")
5. Move in the front of coverage area. The lights should turn on automatically. When functional test is complete, set DIP Switches, Time Delay and Light Level to the desired settings, and put the front cover back on the sensor.

DIP SWITCH SETTING

The MDC-50L has 8 DIP switches under the cover. They are used to set PIR sensitivity, time delay, override and trigger mode feature settings.

| | |
|-----------------|---|
| PIR Sensitivity | 1 |
| 50% | ↓ |
| 100% | ↑ |

| Trigger Mode | Initial Trigger | Maintain Load Output | 2 | 3 | 4 |
|--------------|-----------------|----------------------|---|---|---|
| Option 1 | Both | Either | ↓ | ↓ | ↓ |
| Option 2 | Either | Either | ↓ | ↓ | ↑ |
| Option 3 | PIR | Either | ↓ | ↑ | ↓ |
| Option 4 | PIR | PIR | ↓ | ↑ | ↑ |
| Option 5 | Ultrasonic | Ultrasonic | ↑ | ↓ | ↓ |
| Option 6 | Both | Both | ↑ | ↓ | ↑ |

| | | | |
|---------------|---|---|---|
| Time Delay | 5 | 6 | 7 |
| 5 Sec/Autoset | ↓ | ↓ | ↓ |
| 30 Seconds | ↓ | ↓ | ↑ |
| 5 Minutes | ↓ | ↑ | ↑ |
| 10 Minutes | ↓ | ↑ | ↑ |
| 15 Minutes | ↑ | ↓ | ↑ |
| 20 Minutes | ↑ | ↑ | ↑ |
| 25 Minutes | ↑ | ↑ | ↓ |
| 30 Minutes | ↑ | ↑ | ↑ |

| | |
|----------|---|
| Override | 8 |
| Disabled | ↓ |
| Enabled | ↑ |

↓=OFF ↑=ON ◀=Factory Setting

Sensitivity setting: DIP switch 1

- 50% -This setting will decrease the amount of area the sensor will cover to half the range
- 100% , the maximum range of sensor's coverage is 1600 square feet, see "coverage pattern"

Trigger Mode: Switches 2, 3, 4

Follow the DIP Switch Setting Table and use DIP switches 2, 3 and 4 to select 1 of the 6 trigger options.

- **Both:** requires motion detection by the PIR and the Ultrasonic.
- **Either:** requires motion detection by only one technology.
- **PIR:** requires motion detection by the PIR.
- **Ultrasonic:** requires motion detection by the Ultrasonic.

Time Delay: Switches 5, 6, 7

The sensor will hold the lights on as long as occupancy is detected. The time delay countdown starts when no motion is detected. After no motion is detected for the length of the time delay, the sensor will turn the lights off.

Override: Switch 8

To override all sensor functions, set to ON position (DIP Switch 8).

TROUBLESHOOTING

NOTE: There is a 40 seconds warm-up time at initial power-up.

Red LED does not blink:

1. Check that the circuit breaker has been turned back on.
2. Make sure that the PIR Sensitivity is set for 100% (DIP switch 1).
3. Check the Power Pack and make sure there is 24VDC on the red and black low voltage wires.

Both LEDs blink but lights do not turn ON:

1. Check the "Light" setting. If the arrow is pointed to the "–" position, the area needs to be dark enough for the sensor to operate. Cover the light sensor lens to simulate darkness. If the light turns ON, the light level setting needs to be adjusted.
2. Make sure the wires are connected and bulbs are working.
3. Check for obstructions in the lens cover.
4. Make sure that power to the sensor has been ON continuously for at least one minute. Wait for the warm-up period to end.

Green LED does not flash:

Ultrasonic sensitivity setting may need to be increased. Turn clockwise as needed.

Lights do not turn off automatically:

Green LED flashes:

Reduce ultrasonic sensitivity by turning counter-clockwise until it only flashes when movement occurs.

Red LED flashes:

Reduce PIR sensitivity by setting to 50%(DIP Switch 1).

Lights do not turn OFF automatically:

1. If there is no motion from people or equipment in the sensor's view but either LEDs blink, look for any nearby source of infrared energy (heat) in motion, such as turbulent air from a heating or cooling supply.
 - a. Mount the sensor so that its lens is below the edge of the fixture and does not directly view the lamps.
 - b. Move the air supply away from the sensor, or move the sensor.
2. Verify the time delay settings in switches 5-7. Ensure that the time delay is set to the desired delay and that there is no movement within the sensor's view for that time period.
3. Check sensor wire connections.

WARRANTY INFORMATION

This device is warranted to be free of material and workmanship defects for 2 years from the date of purchase. Original receipt or proof of purchase from an authorized retailer must be presented upon warranty claim. ALL claims must be verified and approved by Enerlites, Inc. Warranties from other Enerlites products may vary. This warranty is nontransferable and does not cover normal wear and tear or any malfunction, failure, or defect resulting from misuse, abuse, neglect, alteration, modification, or improper installation. To the fullest extent permitted by the applicable state law, Enerlites shall not be liable to the purchaser or end user customer of Enerlites products for direct, indirect, incidental, or consequential damages even if Enerlites has been advised of the possibility of such damages. Enerlites' total liability under this or any other warranty, express or implied, is limited to repair, replacement or refund. Repair, replacement or refund are the sole and exclusive remedies for breach of warranty or any other legal theory.

